

Fibertherm protect dry 110

External/internal thermal insulation composite system with 110 kg/m³ density wood fiber panels

Beton  Wood

Install instruction

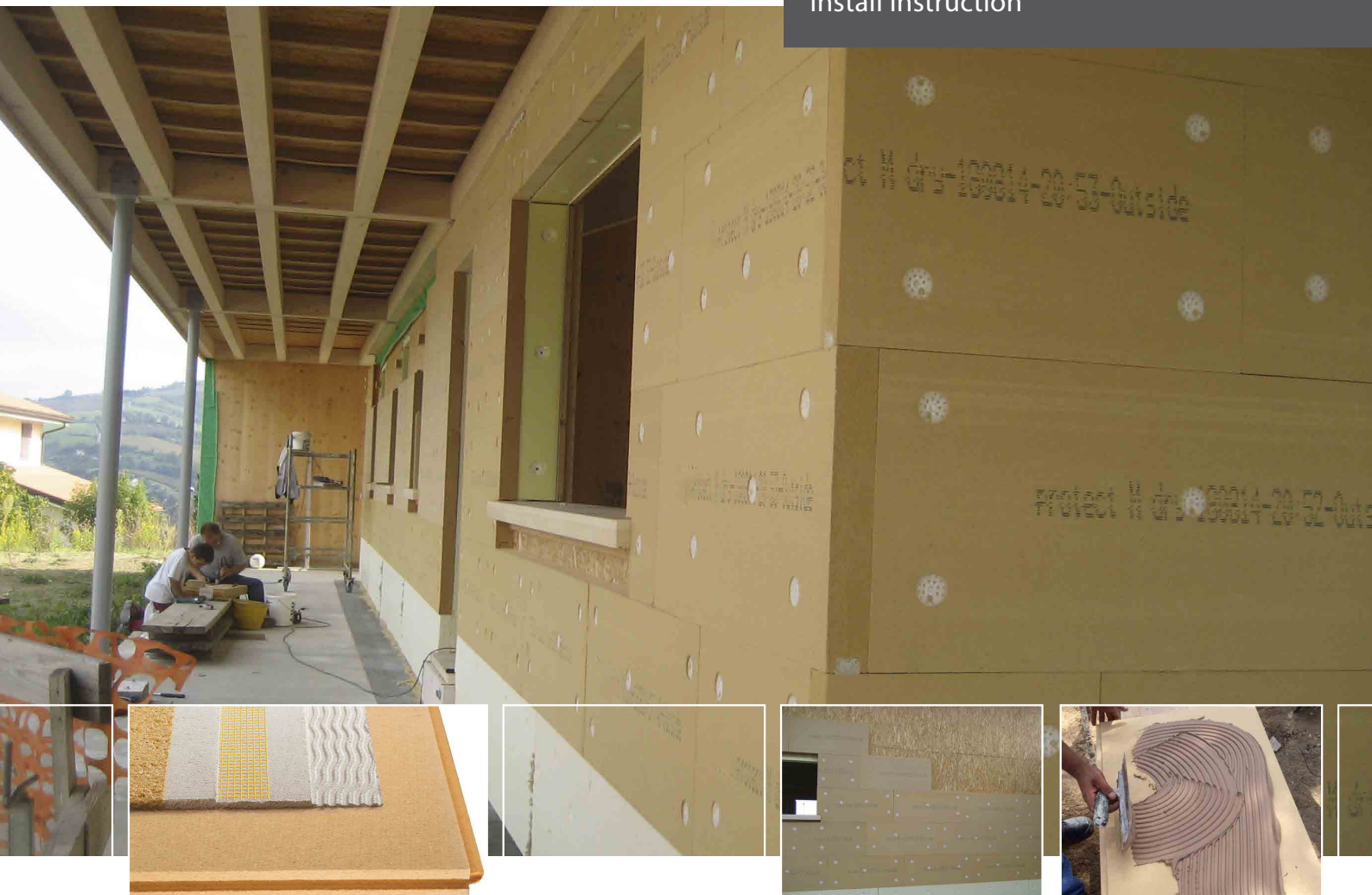

| PRODUCT DESCRIPTION

Fibertherm **protect dry 110** is an insulating wood fiber plaster base panel produced with dry process ongoing quality supervision.

It is a plasterable wood fiber panel for external and internal thermal insulation composite system suitable in 3 density: 110 kg/m³, 140 kg/m³, 180 kg/m³.

| MATERIAL

Wood for Fibertherm **protect dry 110** comes from sustainable forestry and is independently certified by the FSC®.

| THE ECOLOGICAL BUILDING SYSTEM FIBERTHERM PROTECT DRY 110

The BetonWood construction system combines construction and insulation - everything on Basis of the renewable resource wood.

For the production of FiberTherm wood fiber insulation materials, only fresh, untreated softwood from sustainable forestry is used. The fresh wood is then split into fibers and, depending on the type, further processed in one of the following ways:

• WET PROCESS

This method has been proven for decades. The still wet wood fibers are formed into panels. Afterwards, the entire panel is dried. The panel binding is carried out by the wood component lignin. No additional binder is added. The panels are therefore particularly ecological.

• DRY PROCESS

In these methods, the wood fibers are first dried, then wetted with a binder and then formed into panels. These panels are characterized by a low weight, which has an advantageous effect when using large insulation thicknesses. The products from the dry process can be identified by the suffix "dry".

For more informations about the uses and the installation, our offices are ready to answer your questions on www.fibradilegno.com

The thermal insulation system in wood FiberTherm guarantees high performance and durability that make it a reference system in many European countries. The high dimensional stability of BetonWood products, when the thermo-hygrometric conditions change, helps to eliminate the expansion and cracking due to thermal excursion which can reduce the duration of the outer coat. Less dilations and cracks mean an increase in the durability of the insulation system.

| ACOUSTIC WELLNESS

From the acoustic point of view, the BetonWood wood fiber thermal insulation system, having a very low mass, achieves a high noise reduction compared to the traditional masonry, generating the known "mass-spring-mass" effect. The spring is represented by FiberTherm protect dry wood fiber panels which, thanks to the fibrous structure with open cells, allow to obtain high values of acoustic insulation. The "mass-spring-mass" effect leads to an increase in the sound absorption value that would occur only with the base wall; this increase depends not only on the type of insulation used, on the thickness and on the surface mass of the finishing layer.



One of the main functions of the building envelope is to reduce the heat exchange between inside and outside: in winter, when heat losses must be avoided, and in summer, when internal overheating must be reduced.

In planning, therefore, it is fundamental to establish which are the thermal exchanges between inside and outside, without neglecting the other important

aspects related to the people wellness, such as acoustic comfort, the ability to control the flow of water vapor, the airiness and safety.

A substantial part of the thermal dispersions of a building, in general, occurs through the perimeter walls and the thermal bridges between connections. The insulation of the walls is therefore essential in order to reduce thermal dissipation, to obtain significant savings in terms of economic comfort and advantages in terms of living comfort.

The exterior insulation composite system consists in the application, on the entire external surface of the building, of wood fiber panels, available in different densities, protected on the external side by a layer of reinforced plaster with a medium density glass fiber net, and a surface finish layer.

| THERMAL AND HYGROMETRIC BEHAVIOR

The thermal composite system allows continuous insulation in correspondence with buffer and structural elements with consequent correction of thermal bridges. In this way the thermal dispersions are reduced through the perimeter walls and the support structure is placed in a condition of complete "thermal stillness", reducing the tensions deriving from temperature changes that would occur without this type of protection.

Thanks to this constructive system it is possible to obtain high performance closing systems that allow a significant reduction in energy consumption for both winter and summer air conditioning.

Also from the hygrometric point of view, the use of wood panels ensures excellent behavior thanks to the nature of the material itself which has a coefficient of resistance to the diffusion of water vapor " μ " equal to 5 and guarantees a high permeability of the closing packet .

Through the execution of an external insulation in wood fiber, it ensures an effective exploitation of the thermal inertia of the masonry and a high thermal displacement, thus obtaining a better control of the internal temperatures and making the composite system a construction technology also suitable for warm climates, where during the summer season it is of particular importance, for the purposes of well-being and living comfort, to guarantee a control of the transmission of heat from the external to the internal environment.



The thermal insulation system is recommended both in new buildings and in renovations. It improves the energy performances and allows the rooms usability during installation.



| ACOUSTIC STANDARD

The minimum acoustic requirements required for the sound insulation of the façade, according to the DPCM 5/12/1997 - "Determination of the passive acoustic requirements of buildings, are as follows:

Living areas categories	$D_{2m,nT,w}$
Hospitals, clinics, nursing homes and similar	45
Residences, hotels, pensions and similar activities	40
Schools at all levels and similar buildings	48
Office buildings, recreational or religious activities commercial or similar activities	42

Where $D_{2m,nT,w}$ is the evaluation index of the normalized acoustic insulation of the façade and is in fact connected to all the acoustic bridges and holes present in the façade.



| SUSTAINABILITY

The BetonWood wood fiber thermal insulation composite system, both for new buildings and for renovations, is a fundamental element for the reduction of energy consumption, as the reduction of dispersion from walls. Correct insulation greatly reduces energy consumption to heat or cool a given room, while also allowing the building's energy class to be improved.

FiberTherm wood fiber insulation panels, made from wood from a well-known forest region, are certified to FSC® standards.

The wood of our products also gives another important contribution from the ecological point of view. In fact, wood stores carbon dioxide (CO₂): while growing, trees extract large amounts of CO₂ from the atmosphere, responsible for the greenhouse effect, and store it in the wood in the form of carbon. A tree can store almost a ton of CO₂ in one cubic meter of wood, producing at the same time about 0.7 tons of oxygen.

Those who use the FiberTherm insulation material thus make an immediate contribution to the solution of climate problems.



Das Zeichen für verantwortungsvolle Waldwirtschaft



| INSTALL AND DESIGN INSTRUCTIONS

In order to guarantee the high performance of BetonWood thermal insulation composite systems, special attention must be paid both to the design phase and to the installation. Before starting the installation of the wood fiber thermal insulation composite system, it is advisable to check the substrate on which it will be installed, checking the suitability of the surface and the absence of cracks, efflorescence, dusty substrates and infestations.

The external thermal insulation composite system can be used both on timber-type walls, on traditional masonry and on solid mineral foundations. The thermal insulation composite system components (wood fiber insulation panels, fixings, reinforcement, coating products and accessories) are designed in accordance with the general building inspectorate approval. That gives you security.

For various requirements and working methods, BetonWood has the right panels in small and large format as well as with a sharp edges, or with tongue and groove in program.

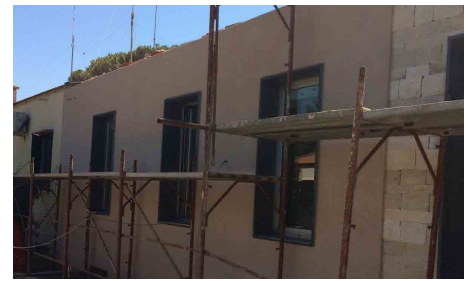

| TIPS

- Allow sufficiently large roof overhangs (or terraces / balconies) as constructive component protection
- Do not select too dark colors (light reference value ≥ 20)
- Adjust the plaster thickness to the local climatic conditions (eg driving rain)
- Do not select cleaning grain size too small (recommendation: ≥ 2 mm)
- In the case of increased requirements on the design (dimensional tolerances), this must be agreed with the client accordingly (DIN 18202, VOB / C - "Special Performance")
- Pay attention to plant growth in the environment with regard to microorganisms on the plaster surface
- Adjust the exterior lighting to the plaster surface

| FIRE BEHAVIOR

FiberTherm thermal insulation composite systems are classified as normally flammable. Thus, the application for buildings of classes 1 - 3 is possible without additional measures.

Wall constructions with fire resistance classes from F30-B to F90-B can be manufactured with FiberTherm thermal insulation composite systems.

| PHASES

The thermal insulation composite system installation must be executed following the phases:

- examination and preparation of the underground
- panels bonding
- tessellation system
- armed skimming
- finishing layers

During the whole process of the system, the ambient temperature, of the support and of the materials must be at least 5 °C and not exceed 30 °C.

| PHASE 1 - EXAMINATION AND PREPARATION OF THE UNDERGROUND

Wooden substrates

Immediately before mounting the panels, the substrate must be carefully checked. It must be level / offset-free, clean, dry (wood moisture $\leq 20\%$) and sufficiently wide for fixing.

For wooden frame constructions, the maximum permissible axis dimension of the compartments must be checked.

Mineral substrates

The substrate must be dry, dust-free, even and free of separating substances.

In masonry construction in particular, the interior plaster work should be completed before the thermal insulation composite system is installed, so that the exterior walls are not exposed to increased humidity. Especially in new buildings, it is important to ensure continuous protection against rainwater before installing thermal insulation. Moisture penetration of the mineral substrate is not permitted.

In particular, in the renovation of old buildings is important to ensure that rising damp is excluded. Before installing the insulation panels, to be able to carry out a corresponding impact-proof connection.

Loose plaster layers are to be removed, defects must be compensated.

Unevenness up to approx. 10 mm can be compensated with our mineral bonding and reinforcing mortar. For larger bumps, a leveling plaster should be applied, which must be completely dry before plastering. Alternatively, the installation of an additional wooden frame construction can be provided.

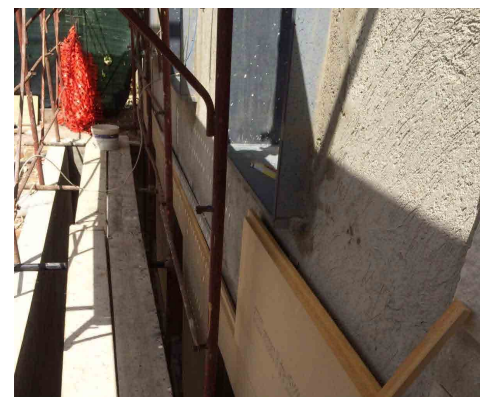



| STORAGE /TRANSPORT

Store FiberTherm **protect** **dry** boards lying flat. Store in a dry area.

Protect edges against damage. Remove foil packing only when the board is ready to be installed.

For dust extraction please refer to national requirements.

National building regulations have to be observed .

| PANELS PROCESSING

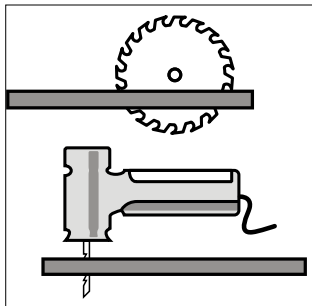

To process FiberTherm **protect** and FiberTherm **protect dry** wood fiber insulation panels, BetonWood recommends to use conventional wood-cutting tools (circular saw, jigsaw, sword chainsaw).

When cutting wood fiber insulation panels, suitable measures must be taken (dust extraction, filter systems). The usual safety regulations for the processing of wood-based materials apply.

| PHASE 2 - PANELS BONDING

The wood fiber insulating panels bonding to the substrate must be made using adhesive mortars (glues), specifically designed for thermal insulation composite systems in wood fiber material. In the case of double density panels, the adhesive mortar must be applied to the lower density side. Subsequently the panels must be installed on the surface which has to be insulated, installing them perfectly together with joints offset.

It is recommended to install the FiberTherm insulation composite system on dry, clean, regular and stable surfaces.

The high dimensional stability of the insulating panels made of FiberTherm wood, which does not generate expansion-shrinkage, allows the execution of two different glue installation: "to curbs and points" or "to full surface".

a. CURBS AND POINTS BONDING

this scheme is indicated if it is necessary to correct flatness defects of the support. The mortar must be placed on the back of the panel along the entire perimeter, for a length of 5-10 cm, and in the middle of the same in one or more points of diameter 10-15 cm. The contact surface between panel/glue and glue/masonry must never be less than 40% of the panel surface.



b. TOTAL SURFACE BONDING

this scheme is indicated in the case of a sufficiently regular and planar support. With a toothed trowel (dentition depending on the flatness of the support) the adhesive is spread over the entire surface of the panel.



In both cases, the mortar must not be applied to the side surface of the panel, to ensure continuity and perfect adherence of the insulation and to avoid the onset of thermal bridges. In order for the gluing to be effective, the glue-smoothing agent must penetrate between the surface fibers of the panel.



| JOINT OFFSET

The tongue&groove panels are processed horizontally with floating joints horizontally, a minimum offset of the vertical (short) panel joints of 30 cm between the laying rows must be observed. Vertical joints in a compartment directly above one another (cross joints) are not permitted.

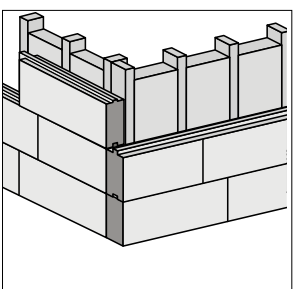
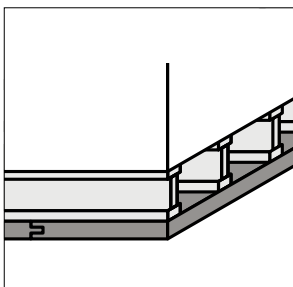
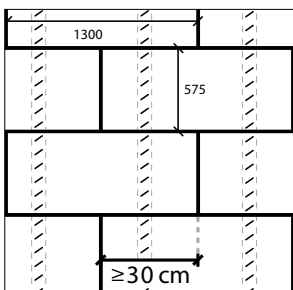
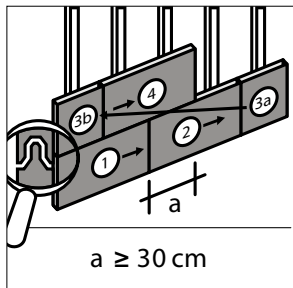

| PHASE 3 - PANELS MONTAGE AND FIXING

For tongue&groove panels, the groove profiling of the lower longitudinal side of the panel must be removed for the first assembly row so that a sharp edge is created. Even with corner designs, sharp edges are to be provided. Profiled panels are mounted with tongue edge.

The stamping on the plates indicates the laying side. For cutting optimization FiberTherm protect 265 / FiberTherm protect 230 panels as well as FiberTherm protect dry 180/ FiberTherm protect dry 140 panels can be turned.

When installing the FiberTherm protect / FiberTherm protect dry wood fiber insulation boards in the opening area, make sure that the boards are not pushed vertically or horizontally directly into the opening corners, but are offset by a distance of at least 15 cm. As a result, stress concentrations in the insulation panel plane is counteracted (the additional arrangement of the diagonal reinforcement strips in the reinforcement layer is to be observed).

If there is still a pile joint in the opening corner, this joint should be glued.

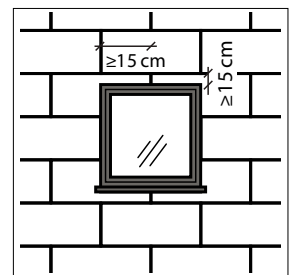
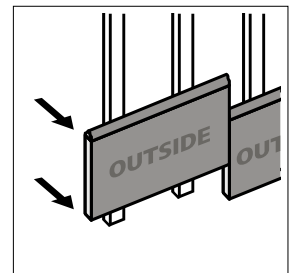
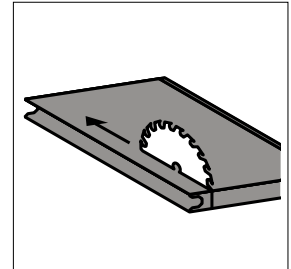

PANEL MOUNTING ON WALL SURFACES

The single panel must be attached to at least two stems. If there is an attachment to a handle, as with corners, the vertical joint must be glued.

When using FiberTherm zell as a filler material possibly the grid spacing of the substructure can be reduced in the edge region, in order to achieve a higher stability.

PANEL MOUNTING FROM BELOW

A panel mounting from below, e.g. at protruding upper floors is necessary, with FiberTherm protect 265 or FiberTherm protect dry 180 panels can be made in a thickness of 60 mm. The grid dimension must not be exceeded 41.7 cm. The number of fasteners increases by ¹/₃.

PANEL MOUNTING ON WALL SURFACES

The single panel must be attached to at least two stems. If there is an attachment to a handle, as with corners, the vertical joint must be glued.

When using FiberTherm zell as a filler material possibly the grid spacing of the substructure can be reduced in the edge region, in order to achieve a higher stability.

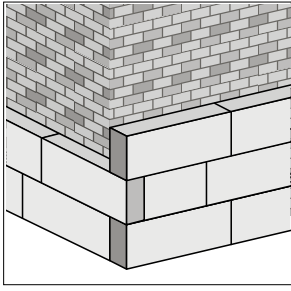

PANEL MOUNTING FROM BELOW

A panel mounting from below, e.g. at protruding upper floors is necessary, with FiberTherm **protect 265** or FiberTherm **protect dry 180** panels can be made in a thickness of 60 mm. The grid dimension must not be exceeded 41.7 cm. The number of fasteners increases by ¹ / ³.

CORNER FORMATION

FiberTherm **protect 265** and FiberTherm **protect dry** panels don't need to be interlocked in timber construction in the corner area.

With an adhesive mounting of sharp edged panels on mineral substrates, a corner gearing is necessary. Bonding of the vertical and horizontal joints is not necessary here.

An attachment to a stalk located in the corner is sufficient.

If this is not the case, it is necessary gluing the vertical joint with a sealant between the front surface and the back of the corner panel.

The recommended sealant is applied as a bead (diameter approx. 8 mm) in wavy form on the front side of the already mounted panel.

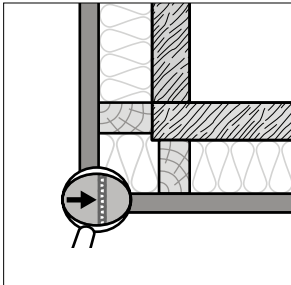

FTH protect or FTH protect dry Thicknesses (mm)	Maximum overhang at the bonded FTH protect or FTH protect dry Outside corners (mm)
40	160
≥60	200

| PHASE 4 - MECHANICAL FIXING

The mechanical fixing must contrast the horizontal forces due to the action of the wind and ensure the stability of the system over time.

The mushroom dowels should preferably be "screw" type with metal core and must have a sufficient length to cross the thickness of the insulator and penetrate into the wall behind it until it reaches a mechanically "reliable" layer.

ETAG certified plugs must be designed specifically for thermal insulation systems and the type varies according to the type of support. The dowels must be applied after the mortar hardening, in variable number depending on the characteristics of the substrate, the height of the building and the atmospheric agents.

The fixing scheme has two variants: T and W.

Predict approximately 7 tiles per square meter.

It is preferable to adopt the W tessellation scheme, since the anchorage is more effective; this scheme is applicable thanks to the high dimensional stability of the wood fiber which does not undergo dimensional variations when the thermohygrometric conditions change.

In both cases the plugs must always be installed in correspondence with the panel portion glued to the support.



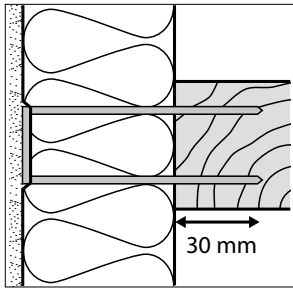

TESSELLATION

FiberTherm **protect** / FiberTherm **protect dry** panels can be anchored in the wood substrate with stainless steel wide-angle clamps or expansion screw anchors.

WIDE BACK CLAMP

(with 60 mm plate thickness, for example, according to AbZ 27 × 100 × 1.8 mm)

- Approved stainless steel wide back clamp according to DIN 1052: 2008-12 or EC 5
- Placing the brackets near the surface as far as possible, i. maximum 2 mm deep and tilted by 30°
- Anchorage depth in the load-bearing wooden substrate min. 30 mm²

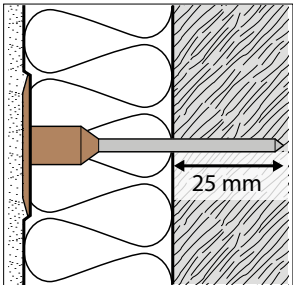

EXPANSION SCREWED DOWEL

- Metal screw with plastic plate
- Torx drive TX 25
- Thermal decoupling of the screw insulation plug, which must be set flush with the surface of the dowel. (Insulating plug is included in the accessories)
- Setting the external screw-in dowel with the top edge of the dowel flush with the wall surface.
- Anchorage depth in the load-bearing wooden substrate acc. Approval min. 25 mm²

In addition to glueing with a mineral bonding and reinforcing mortar, the plaster base panel must be fastened with our expansion screw anchors. Depending on the wind load, an associated dowel pattern results.

The dowelling may only take place when the adhesive and reinforcing mortar has set completely. The anchoring of the dowels in the subsurface must be carried out in accordance with the building supervisory approval of the dowel manufacturer.

In the outdoor area, our expansion screw dowels must be flush with the wall surface with the upper edge of the dowel.

Finally, the screw holes of our expansion screw anchor are sealed with the special insulation plug. This must be flush with the surface in the dowel.



Minimum number of dowels / m² according to approval

Panel thickness (mm)	Dowel load class (kN/Dowel)	Wind pressure w _e (Wind suction) acc. to standard 1055-4 (kN/m ²)		
		-0,55	-1,00	-1,60
≥ 100	≥ 0,15	6	8	10

• Panel size 1200 x 400 mm (spessore 100 - 240 mm)

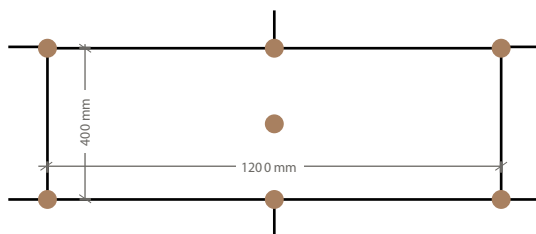

FiberTherm **protect dry 110**

Wind pressure w_e | to -0,55 kN/m²
Number | 6,3 pieces/m²

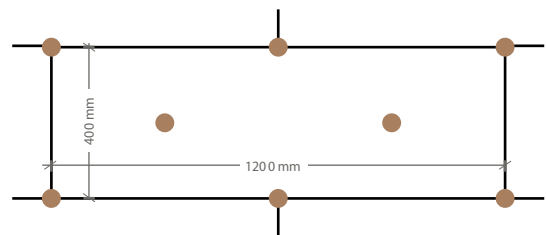

FiberTherm **protect dry 110**

Wind pressure w_e | to -1,00 kN/m²
Number | 8,3 pieces/m²

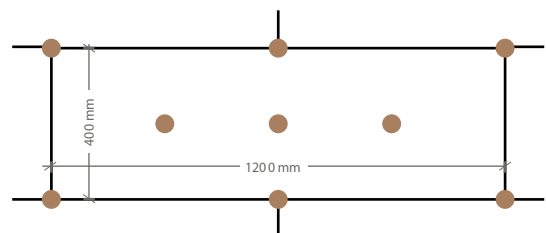

FiberTherm **protect dry 110**

Wind pressure w_e | to -1,60 kN/m²
Number | 10,4 pieces/m²



| PHASE 5 - REINFORCED SKIMMING LAYER

The skimming layer of insulating wood fiber panels 3-4 mm thick must be executed with BetonWood approved mortars, specifically designed for wooden fiber thermal insulation composite systems (this is usually the same product used for bonding).

To ensure that the skimming layer is effective, it is necessary that the glue / skimming mortar penetrates between the surface fibers of the panel.

When the mortar is still wet, we can proceed with the installation of glass fiber net on the masonry from the top to the bottom (as we can see in figures).

Afterwards, we can place the second hand of skimming mortar is laid, so that the fiber glass net is drowned in the skimming mortar.



The recommended glass fiber net is BetonNet with a density of 160 g / m² and ETAG certified.

The reinforcement glass fiber net has the function of supporting the tensions generated in the skimming layer due to thermal changes and microthermal effects: it is essential to prevent cracks from forming in the plaster. The net must be specifically designed for exterior systems and must consist of alkali-resistant glass fiber.



The corners must be protected with angles (generally in polymer with net) applied with adhesive mortar.

As regards the thickness of the layers, timing and climatic conditions of installation, please refer to the manufacturer's instructions for the skim coat.

| PHASE 6 - FINISHING LAYER

The external finish must withstand bad weather and temperature changes. Furthermore it must be impermeable to water and steam coming from inside the building. It can be colored in paste: in this case it must be characterized by a reflection index of more than 20%; in case it is painted later, the painting must have the same characteristics of reflection.

We recommended paints specifically designed for wood fiber FiberTherm thermal insulation composite systems.



Completing and integrating the installation of the wood fiber thermal insulation composite system is the creation of the starting base and the resolution of specific technical details, such as the protection of corners and edges, the connections to other construction elements (eg roofing, windows, etc.) and the possible application of special coatings, for which the manufacturer's instructions must be respected. The design and executive attention to be put in the resolution of these details is crucial in order to guarantee the correct functioning of the thermal insulation system in wood fiber and its durability over time.

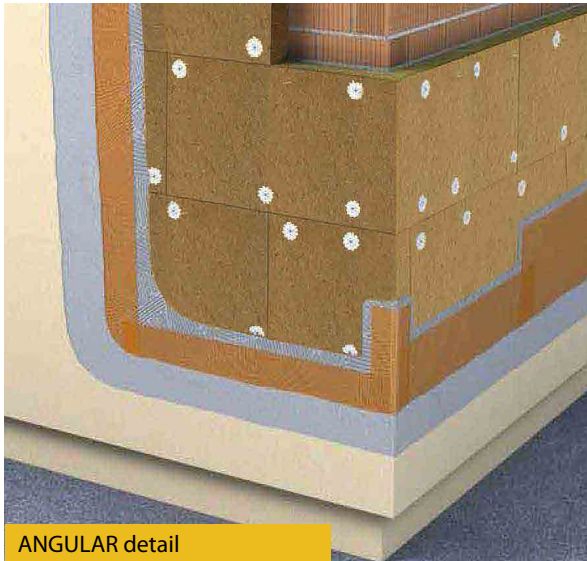

ANGULAR detail

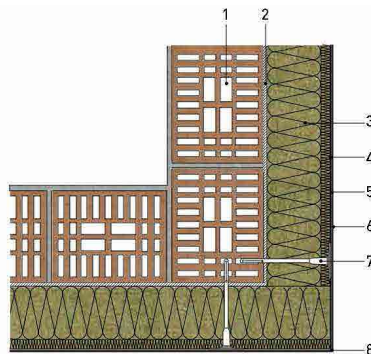

1. Wall structure
2. Bonding layer
3. FiberTherm protect dry 110 panels
4. Reinforced skimming layer
5. Second skimming layer
6. Siloxanes finish
7. Dowels
8. Reinforced angular profile with net

In correspondence of corners and edges it is necessary use whole or half-fold panels laid staggered between them. The panels should be placed side by side, ensuring a regular pose that respects the perpendicularity of the geometry. The adhesive mortar must never be present between the joints of the panels. The profile for the edges protection with fiberglass net must be drowned in the skimming layer, connecting it to the masonry net with an overlap of at least 10 cm.

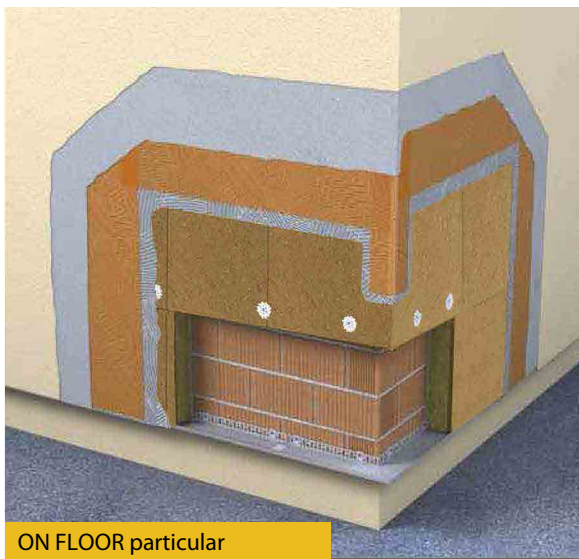

ON FLOOR particular

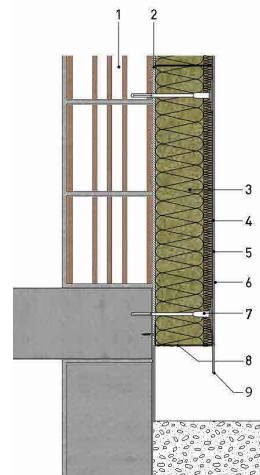

1. Wall structure
2. Bonding layer
3. FiberTherm protect dry 110 panels
4. Reinforced skimming layer
5. Second skimming layer
6. Finish
7. Dowels
8. Starter aluminum profile
9. Alu profile

In consideration of the greater stress due to splashes of water, dirt and possible mechanical actions, a suitable starting point must be used for the plinth areas and, in specific cases, also a 30 cm high EPS panel.

The starting metal profile must be adequately sized to the thickness of the insulating panel and mechanically fixed to the wall support, using fittings for the joints between profile parts. Any unevenness of the profile can be corrected by using specific spacers.

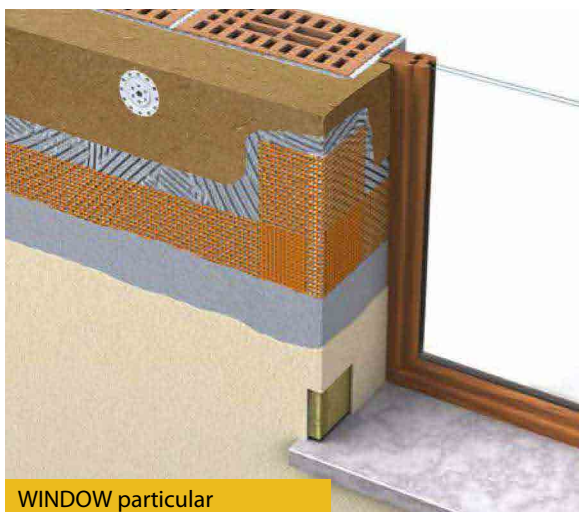

WINDOW particular

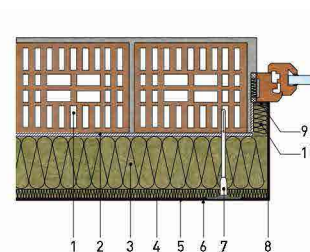

1. Wall structure
2. Bonding layer
3. FiberTherm protect dry 110 panels
4. Reinforced skimming layer
5. Second skimming layer
6. Finish
7. Dowels
8. Reinforced angular profile with net
9. Seal tape
10. FiberTherm protect 265 panels

The connection detail of the thermal cover to the frame mounted inside the masonry must be designed creating a certain continuity of insulation even at the shoulders, in order to avoid the formation of thermal bridges.

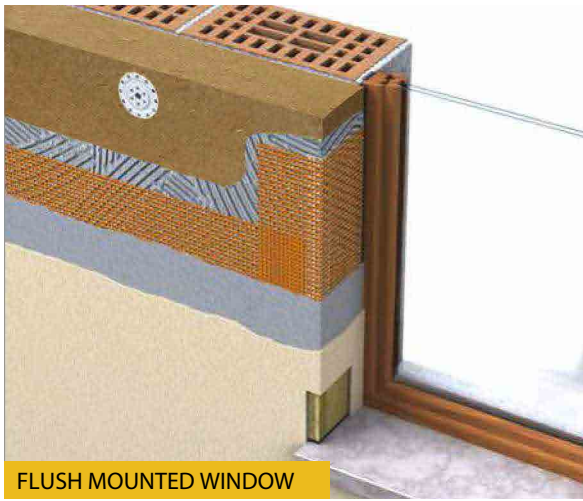

FLUSH MOUNTED WINDOW

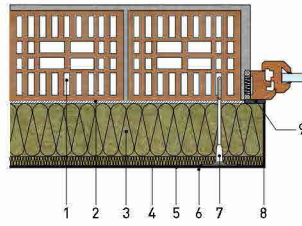

1. Wall structure
2. Bonding layer
3. FiberTherm protect dry 110 panels
4. Reinforced skimming layer
5. Second skimming layer
6. Finish
7. Dowels
8. Reinforced angular profile with net
9. Seal tape

The connection detail of the thermal cover to the frame mounted on the outside of the wall must be designed and executed by realizing the overlap of the insulation on the frame, in order to avoid the formation of thermal bridges.



In both cases the covering system must be completed by using special self-expanding seals placed at the window and sill, profiles in mesh for the protection of the edges and diagonal reinforcement nets to be placed on the corners of the windows with a 45° inclination.

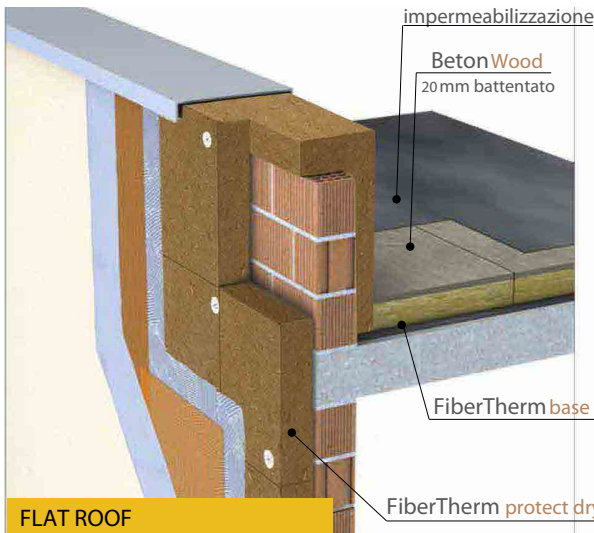

FLAT ROOF

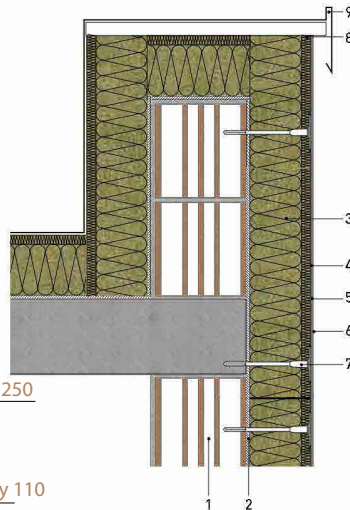

1. Wall structure
2. Bonding layer
3. FiberTherm protect dry 110 panels
4. Reinforced skimming layer
5. Second skimming layer
6. Finish
7. Dowels
8. Seal tape
9. Waterproofing system

The connection detail of the thermal cover to the flat covering must be made by overlapping the insulating panels to the parapet elements and connecting them to the insulating system of the roof. In this way, continuity is given to the thermal envelope. In connection with the flat roofing elements,

it is also essential to protect the coat with metal flashings to avoid water infiltration inside the system.

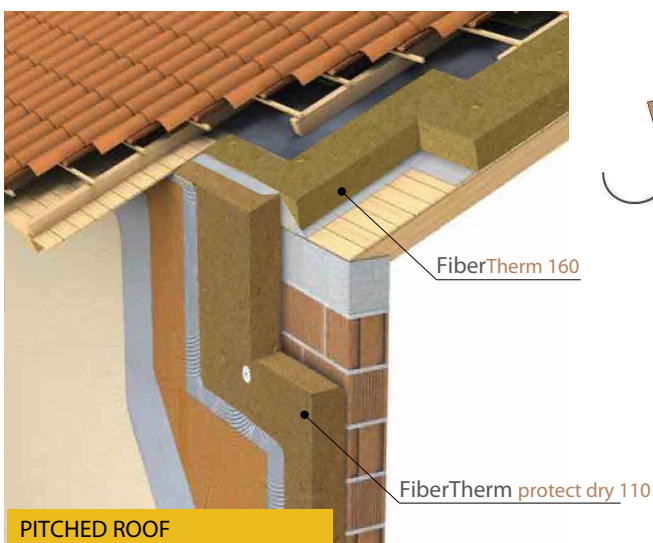

PITCHED ROOF

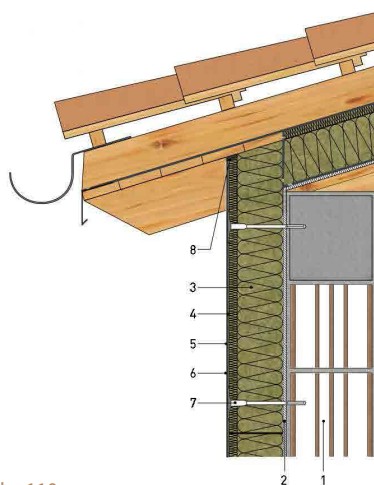

1. Wall structure
2. Bonding layer
3. FiberTherm protect dry 110 panels
4. Reinforced skimming layer
5. Second skimming layer
6. Finish
7. Dowels
8. Seal tape

The insulating panels in wood fiber placed in correspondence of the areas of connection to the inclined roof must be shaped in accordance with the inclination of the roof and laid providing the application of suitable gaskets; in this way it is possible to guarantee the absence of thermal bridges in the area connected to the roof and the correct construction of the joint.

Furthermore, to guarantee the absence of unwanted chimney effects, for the last one of the panels it is possible to apply the glue both on the panel and on the support ("Floating Buttering").



BETONFIX FIF-CS8

Dowel for installation on masonry

Dowels for fixing and screwing of therm insulation composite systems on masonry support. The composite screw decrease thermal bridges.



BETONFIX 6H-NT

Dowel for installation on wood wall

Dowels for fixing and screwing of therm insulation composite systems on wood wall. The composite screw decrease thermal bridges.



BETONNET 160

Fiberglass net with 160 kg/m³ density

A warp-proof and alkali-resistant glass fiber net used in thermal insulation systems. Ideal for thermal coats in wood fiber or blonde cork.



BETONSTRIP

Adhesive fiber glass mesh tape used as a joint cover near the joints between the plasterboard walls. Ideal with BetonTherm systems.

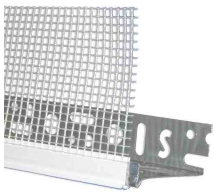

ANGULAR DRIP-OFF STARTER PVC

PVC profile with thermo-welded glass fiber net 165 gr / m² certified ETAG004. Used as a sealed connection between the starting base and the armed skimming layer.



PROFILE STARTER ALU

Non-deformable aluminum profile with thickness between 0.8 and 1.2 mm with drip. Used for the correct lower seal of the insulation system.

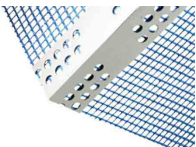

ANGULAR CORNER ALU

Glass fiber net angle 165 gr / m² ETAG004 certified reinforced inside with aluminum profile forming an angle of 90°. Used for reinforcement of angles, sharp edges

Head office:
Via Falcone e Borsellino, 58
I-50013 Campi Bisenzio (FI)

T: +39 055 8953144
F: +39 055 4640609

info@betonwood.com
www.betonwood.com

FTHPD IP.18.02



Das Zeichen für verantwortungsvolle Waldbirtschaft

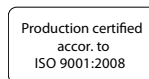

Mitglied der
DGNB
Deutsche Gesellschaft für Nachhaltiges Bauen
German Sustainable Building Council